

Service  
Service  
Service



# Service Manual



## CONTENTS

Technical specification .....1

Service measurement setup.....1-3

Service aids .....1-4

Instructions on CD playability .....2

Block diagram.....3

Wiring diagram .....4

Circuit diagram .....5

Layout diagram.....6

Exploded view diagram .....7

Revision list .....8

© Copyright 2012 Philips Consumer Electronics B.V. Eindhoven, The Netherlands  
All rights reserved. No part of this publication may be reproduced, stored in a retrieval system or transmitted, in any form or by any means, electronic, mechanical, photocopying, or otherwise without the prior permission of Philips.

Published by ZH 1312 Service Audio Subject to modification

3140 038 60100



Version 1.0



# PHILIPS

## AZ127/320/328/329

### Technical Specifications (Sheet-190)

**Type:** CD sound machine

**Performance Class:** According to PQR (Product Quality and Reliability)

Class	Tuner	Power Supply + AMP	CD/MP3	Cassette	USB/SD card	Speaker Box
I	X			X		
II		X	X		X	
III						

### Commercial Set Type/Stroke Versions:

Set Type Number	Stroke Versions	12NC	Region/Countries
AZ127	/12		Europe
AZ320	/12		Europe
AZ328	/12		Europe
AZ329	/98		APAC

Prepared: \_\_\_\_\_  
( R&D Engineer)

Cheeked: \_\_\_\_\_  
(R&D Chief engineer)

Approved: \_\_\_\_\_  
(PHILIPS\_ODM)

Approved: \_\_\_\_\_  
(PHILIPS DEV-Q)

Approved: \_\_\_\_\_  
(PHILIPS QAD)

-		<b>AZ127/320/328/329</b>	-		2012-07-18	
	2		-		2012-10-24	
	3		-		2012-11-11	
NAME	Tang Bing	18	10	190	- 1	A4
	CHECK	DATE	2012-11-16		© BU HAV Consumer Lifestyle, Philips	



**1. INTRODUCTION.....6**

    1.1 Purpose and Scope of Document.....6

    1.2 References .....6

**2. GENERAL INFORMATION AND REQUIREMENT .....7**

    2.1 Product Family Feature .....7

    2.2 Mechanical General Information.....9

    2.3 Safety Standards .....9

    2.4 EMC Requirements .....9

    2.5 ESD Requirements.....9

    2.6 Environmental Condition .....10

    2.7 Quality.....10

**3. TECHNICAL SPECIFICATIONS .....11**

    3.1 Power Supply.....11

    3.2 Technical Description .....13

    3.3 TUNER .....14

    3.4 CD.....15

    3.5 TAPE (Jiansheng JS-21VB8885-SGS) .....16

    3.6 USB/SD CARD: .....17

    3.7 Audio Signal Processing(TBC).....17

**4. MECHANICAL .....18**

-		<b>AZ127/320/328/329</b>	-	2012-07-18	
	2		-	2012-10-24	
	3		-	2012-11-11	
NAME	Tang Bing	18	10	190 - 4	A4
		CHECK	DATE	2012-11-16	© BU HAV Consumer Lifestyle, Philips

**Document History**

Date	Person	Ver	Description
2012-07-18	Tang bing	0.1	▪ First Draft
2012-10-24	Tang bing	0.2	▪ Add USB and SD card information
2012-11-11	Lv Yanhui	1.0	▪ Slide switch function, ESD specification, Tape function.
			▪
			▪
			▪
			▪
			▪
			▪
			▪
			▪
			▪
			▪
			▪
			▪

-					-	2012-07-18	
	2	<b>AZ127/320/328/329</b>				-	2012-10-24
	3					-	2012-11-11
NAME	Tang Bing					18	10
		CHECK	DATE	2012-11-16	© BU HAV Consumer Lifestyle, Philips		

## 1. Introduction

### Purpose and Scope of Document

The sheet 190 is the leading specification and is the response of development to the HAV as requested by Product Management. Whenever the specification cannot be met, Product Management is to be informed as early as possible in order to make sure the marketing can respond in time.

This sheet 190 does not cover software specifications. Software is described in the URS documents and in the version matrix owned by Product Management. Product Management is responsible for maintaining, distributing and updating the version matrix.

Sheet 190 will be part of the Philips official documentation from stage 2 onwards. All changes to sheet 190 have to be submitted via Change Proposals. Changes have to be marked in bold and/ or colours in the document for easy recognition in at least the update right after the change. Deletion of text is done by strike through in order to make changes obvious in at least the update after the change took place.

12NC and EAN codes will follow the overview sent out by product planning group HK.

### References

Reference	Document
[PQR1]	Title PQR (Product Quality and Reliability) Manual Author PCE BLC Audio & Multimedia Applications Version Ver 1.1, 02-10-2006, ref: PQR_Handbook_v2p1 Note: Default class 2 applicable
[CRS]	Title AZ127 family CRS 121024.xls Author Ryan Tam Version 1.0
[AD]	Title AZ127 family VPD draft 120711.pptx Author Ryan Tam Version 1.0

		<b>AZ127/320/328/329</b>				-	2012-07-18	
						-	2012-10-24	
						-	2012-11-11	
NAME	Tang Bing	18	10	190	-	6	A4	
		CHECK	DATE	2012-11-16				© BU HAV Consumer Lifestyle, Philips

## 2. General Information and Requirement

### Product Family Feature

#### 2.1.1 Identity and Key Features

AZ127 family are CD Sound Machine with following feature.

Model	FM	CD/MP3	Tape	Audio-in	USB
AZ127	Y	CD	Y	Y	N
AZ320	Y	CD/MP3	N	Y	N
AZ328	Y	CD/MP3	Y	Y	Y
AZ329	Y	CD/MP3	Y	Y	Y, USB/SD card

Elements to include as generic requirements:

1. Non-detachable mains cord for 12 and detachable mains cord for 05.
2. Safety certification (cUL/FCC and CB/EMC/CE)

Following is a list of key features:

1. CD for AZ127 or CD/MP3 for AZ320/328/329 Playback
2. Tape playback for AZ127 and AZ328/329
3. Audio-in (via headphones jack from PC or MP3 player)
4. USB playback for AZ320/328, USB/SD card playback for AZ329
5. Tuner FM
6. DBB control for customer favourite sound
7. Rated output power=2x1W @10%THD.

#### 2.1.2 Styling, Forms and Functions

AZ127/320/328/329 portable CD sound machine, can be place bed room with AC power and also use outside with LR14x6 battery power

#### 2.1.3 External I/O Connections

Model	AZ127	AZ320	AZ328	AZ329
Stroke Version	/12	/12	/12	/98
Region	Europe	Europe	Europe	APAC
MP3 Link (3.5mm audio jack)	√	√	√	√
USB port	NA	√	√	√
SD card	NA	NA	NA	√

-				-	2012-07-18	
	2	<b>AZ127/320/328/329</b>			-	2012-10-24
	3			-	2012-11-11	
NAME	Tang Bing	18	10	190	- 7	A4
		CHECK	DATE	2012-11-16	© BU HAV Consumer Lifestyle, Philips	

**2.1.4 Controls, Local Display and LED Indications**

Slide switch for source selection:

TAPE → FM → AUDIO-IN/CD --- AZ127  
 OFF → FM → USB → AUDIO-IN/CD --- AZ320  
 TAPE/OFF → FM → USB → AUDIO-IN/CD --- AZ328  
 TAPE/OFF → FM → USB/SD card → AUDIO-IN/CD --- AZ329

Control keys on the set are:

AZ127

1. Power on/off
2. Play/Pause
3. Stop
4. Program
5. Repeat
6. Shuffle
7. Net
8. Preview
9. DBB (push button)

AZ320/328/329 :

1. Play/Pause
2. Stop
3. Program
4. Mode
5. Next
6. Preview
7. Album+
8. Album-
9. DBB (push button)

Knob control on the set are:

1. Volume
2. FM tuning

-		<b>AZ127/320/328/329</b>	-	2012-07-18
	2		-	2012-10-24
	3		-	2012-11-11
NAME	Tang Bing	18	10 190 - 8	A4
	CHECK	DATE	2012-11-16	© BU HAV Consumer Lifestyle, Philips



**Mechanical General Information**

The product appearances and functions are defined in their respective MUS. Product management approves the MUS and it is a leading document where product appearance is applicable.

Please refer to Sh560 for mechanical information.

**Safety Standards**

Where applicable:

For /12 (EU), /05 (UK), /51 (Russia)	EN/IEC 60065 7 <sup>th</sup> Edition
For /37 (US, Canada)	UL 60065
For /55 (LATAM), /78 (Brazil)	IEC 60065 7 <sup>th</sup> Edition
For /98 (AP), /69 (Singapore), /75 (Australia)	IEC 60065 7 <sup>th</sup> Edition
For /93 (China)	GB 8898 (IEC 60065 7 <sup>th</sup> Edition)
For /61 (Korea)	K 60065 6 <sup>th</sup> Edition
For /96 (Taiwan)	CNS 14408 (IEC 60065 7 <sup>th</sup> Edition)

**EMC Requirements**

Where applicable:

For /12 (EU), /05 (UK), /51 (Russia)	EN55013: 2001, EN55020: 2002
For /37 (US, Canada)	FCC15
For /55 (LATAM), /78 (Brazil)	CISPR13
For /98 (AP), /69 (Singapore), /75 (Australia)	CISPR13
For /61 (Korea)	CISPR13/20
For /93 (China)	GB 13837 (CISPR13)
For /96 (Taiwan)	CNS 13439 (CISPR13)

**ESD Requirements**

The product shall withstand electro static discharges on all user accessible parts of the product.  
Reference: IEC61000-4-2.

For contact discharges:

Level	General (kV)	USA (kV)	Requirement
1	0-2	0-3	No deviations allowed.
2	>2-4	>3-4	Short perceptible deviations allowed.
3	>4-5	>4-5	Normal recallable functions function changes allowed.
4	>5-7	>5-7	Control recallable functions function changes allowed.
5	-	>7-8	No loss of stored data allowed.

For air discharge:

Level	General (kV)	USA (kV)	Requirement
1	0-4	0-6	No deviations allowed.
2	>4-8	>6-8	Short perceptible deviations allowed.
3	>8-10	>8-10	Normal recallable functions function changes allowed.
4	>10-15	>10-15	Control recallable functions function changes allowed.
5	>15	>18	No loss of stored data allowed.

		<b>AZ127/320/328/329</b>				-	2012-07-18
						-	2012-10-24
						-	2012-11-11
NAME	Tang Bing	18	10	190	-	9	A4
CHECK		DATE	2012-11-16		© BU HAV Consumer Lifestyle, Philips		

General requirement:

1. 10 arcs for positive and negative polarity for unit "on" and "off" for 1kV incremental steps.
2. Component or mechanical damage is not allowed. No loss of fixed stored data (stored in EEPROMs).
3. Hang-ups and malfunctions are allowed, as long as the customer can "recover" from the hang-up by pressing the Standby or ON/OFF button of the set.
4. Failures that disappear only by unplugging the AC mains cord and/or power sources are not acceptable.

**Environmental Condition**

The environmental condition requirements and test method is according to UAN-D1590.

Ambient temperature : max. 40 ° C - all climates  
 Apparatus acc. to spec. : +5 to + 35 ° C

Vibration test (acc. IEC 60 068/2/6) : operational vibration test to be proceeded in operating position of the set.

**Quality**

PQR-class: class 2 according to BLC V&MA PQR handbook V2.1 (2006-10-02)  
 Lifetime: 7 years  
 Tested According to: General Test Instruction UAN-D 1591  
 Measured According to: UAN\_L 1059 unless otherwise stated

-		<b>AZ127/320/328/329</b>	-	2012-07-18	
	2		-	2012-10-24	
	3		-	2012-11-11	
NAME	Tang Bing	18	10	190 - 10	A4
	CHECK	DATE	2012-11-16		
© BU HAV Consumer Lifestyle, Philips					

### 3. Technical Specifications

#### Power Supply

##### 3.1.1 Type and versions

Built in transformer will be used for all models and stroke versions.

Versions	Region/Country	Power supply
12/05	EUROPE / UK	AC 207~253V
37	NAFTA	AC 99~132V
55	LATAM	AC 93.5~146V; 198~264V
98	APAC	AC 207~253V
94	India	AC 170~280V

All requirements per defined for each country should be met with sufficient testing.

##### 3.1.2 Surge Immunity (Lightning Test)

The product shall withstand mains interference's of:

###### Differential mode:

- 2kV/2 ohm criteria C for Europe.
- 6kV/12 ohm criteria C for NAFTA.

###### Parameters:

- Bi-wave
- Open circuit voltage: 2/50us
- Short circuit current: 8/20us
- From +/-1kV to +/-2kV (for Europe) or +/-6kV (for Nafta) in steps of 1kV.
- 10 shots per combination.
- One shot per minute.
- Serial impedance: 2 Ohm for Europe, 12Ohm for Nafta.
- Polarity and phase: Positive (phase 90°) & Negative (phase 270°)

###### Common mode:

- 6kV/2 ohm criteria C for Europe.
- 6kV/12 ohm criteria C for Nafta.

###### Parameters:

- Ring-wave (100kHz)
- From +/-3kV to +/-6kV in steps of 1 kV.
- 10 shots per combination.
- One shot per minute.
- Serial impedance: 2 Ohm for Europe, 12Ohm for Nafta
- Polarity and phase: Positive (phase 90°) & Negative (phase 270°)

Reference: IEC61000-4-5 and for USA: 3135 019 8029 Reliability evaluation.

###### Requirements:

- Apparatus should fulfil the leakage current requirements of IEC60065 point 9.1.1 (UAN-D1631)
- Defects or permanent deviations are not allowed.

-					-	2012-07-18	
	2	<b>AZ127/320/328/329</b>				2012-10-24	
	3					2012-11-11	
NAME	Tang Bing				18	10	190
		CHECK	DATE	2012-11-16	© BU HAV Consumer Lifestyle, Philips		

**3.1.3 Mains Drop-out Immunity**

The product shall withstand mains failures of:

- Variation 0% (=100% dip) at T-event = 50 mSec. Performance criterion B
- Variation 40% (=60% dip) at T-event = 100 mSec. Performance criterion B
- Variation 0% (=100% dip) at T-event = 5 Sec. Performance criterion C

Additional for USA apparatus: See 3135 019 8029 Reliability evaluation.

- Variation 0% (=100% dip) at T-event = 100 mSec in standby mode. Performance criterion B

Requirement:

No misoperation and no interference of user in order to guarantee continuation of performed function.

Reference: IEC61000-4-11 for measuring method refer to UAN-D1724, as far as applicable.

Performance criterions according to IEC61000-4-4 Amendment 1

Performance Requirement

Criterion A - No any degradation of specification.

Criterion B - Temporary degradation / self recoverable.

Criterion C - No damage, resolvable hang-up.

Criterion D - Not recoverable loss of function.

**3.1.4 Power Consumption**

Power consumption at nominal AC input:

1. iPod mode at 1/8 P-rated output power :  $\leq$  8 W
2. Low Power Standby Mode (fulfill ERP2013) :  $\leq$  0.5 W

-		<b>AZ127/320/328/329</b>	-	2012-07-18			
	2		-	2012-10-24			
	3		-	2012-11-11			
NAME	Tang Bing	18	10	190	-	12	A4
		CHECK	DATE	2012-11-16	© BU HAV Consumer Lifestyle, Philips		

**Technical Description**

<b>General Part</b>					
Output Stage	NA	Temperature :	Yes	Short Circuit :	Yes
Indicators					
Standby Mode Indicator : NA					
Power Standby Mode : NA					
<b>Electrical Data</b>					
		Item	Normal	Limit	
Sound	Y	1 Channel Difference	±3dB	-	
DBB	Y(ON/OFF)	2 Hum (Vol <sub>min</sub> --- Vol <sub>max</sub> -20dB)	150nW	-	
Bass	NA	3 Residual Noise(Volume Minimum)	40nW	-	
Treble	NA	4 Channel Separation: 1kHz/10kHz	40dB/35dB		
Loudness	NA	5 THD, Maximal	0.8%	1.0%	
		6 <b>Signal to Noise Ratio</b>	<b>62dBA</b>	<b>57dBA</b>	
		7 Crosstalk	55dB	45dB	
		8 Amplification Reserve	2dB	1dB	
<b>Audio Inputs</b>					
Audio Input Sensitivity(±3dB) rated output power at 1kHz			Audio Output(*1)		
Tuner	FM 67.5kHz, Modulation (Limit:-6dB)		Line Out(Left/Right)	NA	
CD/MP3	-3dB track (Audio Disc 1, Track 1)		Headphone	NA	
USB/SD card	-3dB 1KHz sine wave( 2.0HS)				
MP3_link(front)	600mV±100mV; Rin ≥ 22kΩ				
Output Power(*1)	At THD=10%, 1kHz sine wave		AZ127/320/328/329		
Main Operation for / all version (rms)	Pannel Subwoofer		2 x1W±1dB Na		
Tuner output power(rms)	Pannel Subwoofer		2x1W±1dB Na		
Frequency Response(±3dB)			70Hz-20kHz		
Loudspeaker(Boxes): Separable speaker box			NA		
Speaker driver Impedance:			Right/Left: Subwoofer:		
			4Ω @ 70 Hz ~ 20kHz(3db) Na		

**REMARKS:**

Electrical Parameters are to be measured at Speaker Terminals across rated impedance Load(4ohm) with Rated Input Signal in CD Mode setting in DBB/Loudness Off and Pre-eq at Flat unless specified otherwise.

-				-	2012-07-18
	2	<b>AZ127/320/328/329</b>		-	2012-10-24
	3			-	2012-11-11
NAME	Tang Bing	18	10	190	- 13
					A4
		CHECK	DATE	2012-11-16	© BU HAV Consumer Lifestyle, Philips

**TUNER**

**GENERAL PART**

FM only , and use IC TA2003			
WAVE RANGE	VERSION	TOLERANCE	TUNING GRID
FM 87.5 – 108.00 MHz	/05/12	QUARTZ PRECISION	NA
AERIAL			
FM : telescope 700mm	Execution	- Rotational 180°	

**ELECTRICAL DATA**

AM	Nor.	Limit	Unit	FM	Nor.	Limit	Unit
NA				- 3 dB Limiting Point	20	26	dBf
				Search Tuning Sensitivity(at stereo mode)	35	41	
				Search time digital tuning system.	-	60	S
				IF	10.7		MHz
				Stereo - 46 dB Quieting	48	51	dB
				Modulation Hum	50	45	
				S/N Ratio	50	45	
				Amplification Reverse( $\Delta f=67.5\text{kHz}$ )	0	-4	dB
				Distortion ( RF 1mV, Frq Dev.75 kHz )	2	3	%
				Overall Frequency Response: 63Hz – 12.5KHz	-	$\pm 3$	dB
			Channel separation:400 / 1000 / 5000 Hz. RF input: 68 dBf	26/30/20	20/26/18	dB	

Frequency (MHz)		Noise Limited Sensitivity 26 dB	Image Rejection	IF Rejection	Large Signal Handling	Selectivity S9/300 kHz	
FM 88.0Mhz	Nom.	18	30	64	1000	22	
	Lim.	22	25	45	500	18 (*1)	
FM 98.0Mhz	Nom.	18	30	64	1000	22	
	Lim.	22	25	45	500	18 (*1)	
FM 107.0Mhz	Nom.	18	30	60	116 dBf	45	
	Lim.	22	25	65	108 dBf	25	
	Units	dBf	dB	dB	mV/m	dB	

Susceptibility to unwanted signals(CPU,SMPS,AMP,DSP ...):	Limited(dB)	Normal(dB)	Remark
	-15dB	-20dB	Refer to self pollution curve

REMARKS:

-				-	2012-07-18	
2	<b>AZ127/320/328/329</b>			-	2012-10-24	
3				-	2012-11-11	
NAME	Tang Bing	18	10	190	- 14	A4
CHECK		DATE	2012-11-16	© BU HAV Consumer Lifestyle, Philips		

**CD**

<b>Technical description</b>				
	AZ127	AZ320	AZ328	AZ329
Active components	Silan SC9637	Ali M5676	Ali M5677	Ali M5677
Passive components	Richly R801	Richly R801	Richly R801	Richly R801
<b>Indicators/Display/Keys:</b>				
Display: 2 Digits LCD for Track No., and REPEAT/SHUFFLE .				
Keys: AZ127 - 8 total on unit, 7 for CD: PLAY, STOP, PREVIOUS/NEXT(Search up/down), PROGRAM/PROGRAM review, REPEAT and 1 for ON/STANDBY AZ320/AZ328/AZ329 - 8 total on unit all for CD: PLAY, STOP, PREVIOUS/NEXT(Search up/down), PROGRAM/PROGRAM review, MODE(Repeat, Shuffle) and ALBUM(+1).				
<b>Playability</b> (acc. to AR 30-05-239)				
	Limit	Typical	Test disc	
Wedge	600 μm	900 μm	TNO 7,9 of SBC 444A (7104 099 24990)	
Eccentric	150 μm	200 μm	TNO 1,24 of 200μm disc (7104 099 24960)	
Fingerprint	No audible defect		TNO 11of Subchassis 8A	
Black dot	500 μm	800 μm	TNO 13 of SBC 444A (7104 099 24990)	
Skew 0.6mm	No audible defect		TNO 1,6 of 0.6mm skew (7104 099 28260)	
Bad HF track	No audible defect		TNO 8 of Subchassis 8A	
Heavy fingerprint	No track jumps/plops		TNO 10 of Subchassis 8A	
Playback position	Horizontal, Normal position (Set is located on a flat surface, floor)			
- Playback of above mentioned tracks possible without track loss or audible defects. - Double black dot, max. diameter, thin/thick disk is according to PQR or AR 30-05-239) - Detail result, refer to Playability KOP report				
<b>ELECTRICAL DATA</b>				
	Typ.	Limit		
Output level (TNO1)				1
SNR unwt'd.	60 dB	50 dB		2
SNR wtd. dBA	65 dBA	57 dBA		3
Crosstalk (1kHz)	40 dB	26 dB		4
Crosstalk (10kHz)	30 dB	16 dB		5
Frequency response Vol.max.-20dB (DBB on)	+9dB +3dB	±2dB ±2dB	at 100Hz at 10kHz	6
THD (1kHz, -6 dB)	0.2 %	1 %		7
THD (10 kHz, -20 dB)	< 1 %	< 3 %		8
Channel difference	2 dB	3 dB		9
Frequency accuracy	-	+/-0.5 %		1 0
De-emphasis	15μs / 50μs Switchable via Subcode information			1 1

-				-	2012-07-18
	2	<b>AZ127/320/328/329</b>		-	2012-10-24
	3			-	2012-11-11
NAME	Tang Bing	18	10	190	- 15
					A4
		CHECK	DATE	2012-11-16	
© BU HAV Consumer Lifestyle, Philips					

**TAPE (Jiansheng JS-21VB8885-SGS)**

General description:					
Tape transport	Jian sheng JS-21VB8885-SGS				1
					2
	Inputs	Outputs	Motor/control	Logic control	
Active components			Mabuchi EG530AD-9B		3
Passive components					4
					5
	Noise suppression	Erase head	Recording/PB		6
Active components	None	NA			7
Passive components			NA		8
Mechanical specification:					
Tape speed	4.76 cm/s		Auto stop	Yes	9
Speed control	_____ %		Auto reverse	No	10
Wow and flutter	< 0.48% JIS wtd. % WUN		Wind/rewind	Yes	11
Fast wind/rewind (C60)	Nom=110s, Lim<170s		Mono: REC/PB	No	12
No. of tracks	1 (stereo)		Stereo: REC/PB	PB	13
Mech. noise (ISO 1996)	<38 dBA (play mode)		Mixing	No	14
Noise overall	<46 dBA		Monitoring	No	15
Tape (PB)	IEC I		Remote controlled	No	16
Tape (REC)	IEC I		ECM	No	17
Recording level	No		Pitch control	No	18
Noise reduction system	No		Cue/review	No	19
Sound improvement system	No				20
Indicators:					
Recording level	No				21
Play back level	No				22
Tape counter	No				23
Electrical data:					
Bias system FM/AM	No				24
RIF switch	No				25
Erase system FM/AM	No				26
Erasing damping	No	at 1kHz			27
Channel separation (IEC1)	> 15 dB	at 1kHz			28
Track separation (IEC1)	> 55 dB	at 1kHz			29
Frequency response (PB)	125 to 8000 for IEC I	125 to 8000 for IEC II	at 10dB (6dB for the range of 250Hz to 4kHz)		30
SNR 250nWb/m	> 36dB for IEC I *	> 36dB for IEC II **			31

-				-	2012-07-18		
	2	<b>AZ127/320/328/329</b>			-	2012-10-24	
	3				-	2012-11-11	
NAME	Tang Bing				18	10	190
		CHECK	DATE	2012-11-16	© BU HAV Consumer Lifestyle, Philips		



Signal/hiss 250nWb/m	I	for IEC	for IEC II	32
Signal/hum 250nWb/m	I	for IEC	for IEC II	33
Channel difference (PB)	< 5 dB (IEC I)			34
Distortion 250nWb/m	< 7 % (IEC I)			35
ALC attack time	< 500 ms (typ. 150ms)			36
ALC release time	> 5 sec. (typ. 15 sec.)			37
Crosstalk		Between forward to reverse track		38
<b>REMARKS:</b>	31: * not according to PQR clause 18.5 class I 31: ** Chromium performance not fulfilled  Amplification Reserve for Tape = 1dB ±2dB For details, please see specification SH-190 of ECO-MTF-PA-SD (3140 117 14890).			39

**USB/SD CARD:**

Same as CD(TBC)

**Audio Signal Processing(TBC)**

-				-	2012-07-18
	2	<b>AZ127/320/328/329</b>		-	2012-10-24
	3			-	2012-11-11
NAME	Tang Bing	18	10	190	- 17
		CHECK	DATE	2012-11-16	© BU HAV Consumer Lifestyle, Philips

**4. MECHANICAL**

**4.1.1 Shock Sensitivity**

Refer to Quality plan for the details of the test discs and testing method.

**Requirement:**

No muting, plop sounds, picture freeze/jerk or audible/visible interference when impacting with force of -

- **In the X and Y directions:** F . 3g / 3ms, V = 0.06m/s
  - **In the Z direction:** F . 2g / 3ms, V = 0.04m/s
- Where g = acceleration due to gravity.

**4.1.2 Thermal Performance**

Refer to Quality plan for the details of the testing method.

**Requirements:**

1. Set should function normally
2. Temperature rise of accessible parts such as metallic enclosures (casing) shall not exceed 40°C above the ambient temperature.
3. Temperature rise of PCB prints shall not exceed 85°C
4. Temperature readings of all mechanical / electrical components and modules shall not exceed their specification limits. The calculated junction temperature of semiconductors shall also not exceed spec limits.

**4.1.3 Noise Specifications**

**Test Conditions:**

Measurements are to be made inside an Anechoic Chamber (echo-free environment) with ambient noise of less than 16dBA.

Measurements are to be taken at the following positions: -

- (a) Top-Surface and at center of Front-Cabinet
- (b) Front-Surface and at center of Front-Cabinet.

The microphone is to be positioned **10cm** from above mentioned surfaces.

Set Functional State		Requirement
		Normal
<b>Idle State</b>	Standby Mode	< 20 dBA
	Set On and "No Disc" mode	< 20 dBA
<b>Tray Open/Close</b>	Start/End peak noise	< 65 dBA
	Tray running noise (RMS)	< 50 dBA
<b>CDDA &amp; SACD (Stereo &amp; Multichannel)</b>	Stop to Play peak noise	< 35 dBA
	Play (first & last tracks)	< 30 dBA
	Search Forward & Backward (all speeds)	< 33 dBA
	Pause (first & last tracks)	< 28 dBA
	Jump Forward (first to last track)	< 38 dBA
	Jump Backwards (last to first track)	< 38 dBA
<b>Commercial Disc</b>	Stop to Play peak noise	< 35 dBA
	Play (inner & outermost title, Layer 0)	< 30dBA(TBC)
	Search Forward & Backward (all speeds)	< 35 dBA
	Pause (inner & outermost title, Layer 0)	< 30 dBA
	Jump Forward (inner to outermost title)	< 40 dBA
	Jump Backwards (outer to innermost title)	< 40 dBA
	Layer Jump (layer 0 to layer 1)	< 40 dBA

-			-	2012-07-18
	2	<b>AZ127/320/328/329</b>	-	2012-10-24
	3		-	2012-11-11
NAME	Tang Bing		18	10
			-	18
				A4
		CHECK	DATE	2012-11-16
© BU HAV Consumer Lifestyle, Philips				

# MEASUREMENT SETUP

## Tuner FM

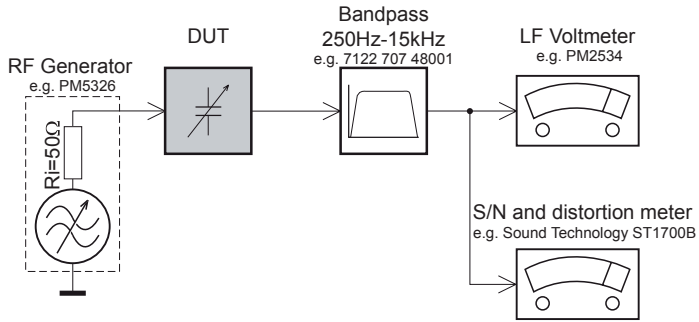

Use a bandpass filter to eliminate hum (50Hz, 100Hz) and disturbance from the pilotone (19kHz, 38kHz).

## CD

Use Audio Signal Disc SBC429 4822 397 30184  
(replaces test disc 3)

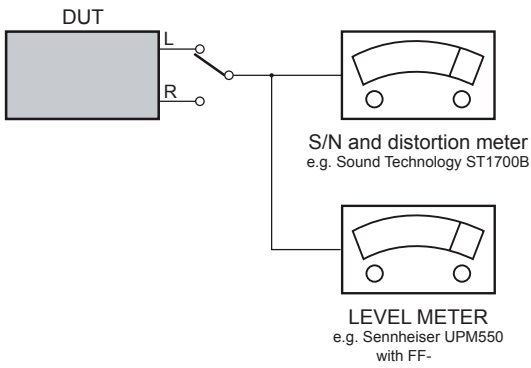

## SERVICE AIDS

### **GB** WARNING

All ICs and many other semi-conductors are susceptible to electrostatic discharges (ESD). Careless handling during repair can reduce life drastically.

When repairing, make sure that you are connected with the same potential as the mass of the set via a wrist wrap with resistance. Keep components and tools also at this potential.

### ESD



### **GB**

Safety regulations require that the set be restored to its original condition and that parts which are identical with those specified, be used

Safety components are marked by the symbol .

**CLASS 1  
LASER PRODUCT**

## INFORMATION ABOUT LEAD-FREE SOLDERING

Philips CE is producing lead-free sets from 1.1.2005 onwards.

### IDENTIFICATION:

Regardless of special logo (not always indicated) one must treat all sets from 1 Jan 2005 onwards, according next rules:



- On our website [www.atyourservice.ce.Philips.com](http://www.atyourservice.ce.Philips.com) you find more information to:
  - \* BGA-de-/soldering (+ baking instructions)
  - \* Heating-profiles of BGAs and other ICs used in Philips-sets
  - \* Lead free

You will find this and more technical information within the "magazine", chapter "workshop news".

For additional questions please contact your local repair-helpdesk.

## SERVICE INSTRUCTION

Safety regulations require that after a repair, the set must be returned in its original condition. Pay in particular attention to the following points:

- Route the wire trees correctly and fix them with the mounted cable clamps.
- Check the insulation of the AC Power lead for external damage.
- Check the strain relief of the AC Power cord for proper function.
- Check the electrical DC resistance between the AC Power Plug and the secondary side (only for sets which have a AC Power isolated power supply):
  1. Unplug the AC Power cord and connect a wire between the two pins of the AC Power plug.
  2. Set the AC Power switch to the "on" position (keep the AC Power cord unplugged!).
  3. Measure the resistance value between the pins of the AC Power plug and the metal shielding of the tuner or the aerial connection on the set. The reading should be larger than 4.5 Mohm (For U.S. it should be between 4.2 Mohm and 12 Mohm).
  4. Switch "off" the set, and remove the wire between the two pins of the AC Power plug.
- Check the cabinet for defects, to avoid touching of any inner parts by the customer.

# INSTRUCTIONS ON CD PLAYABILITY

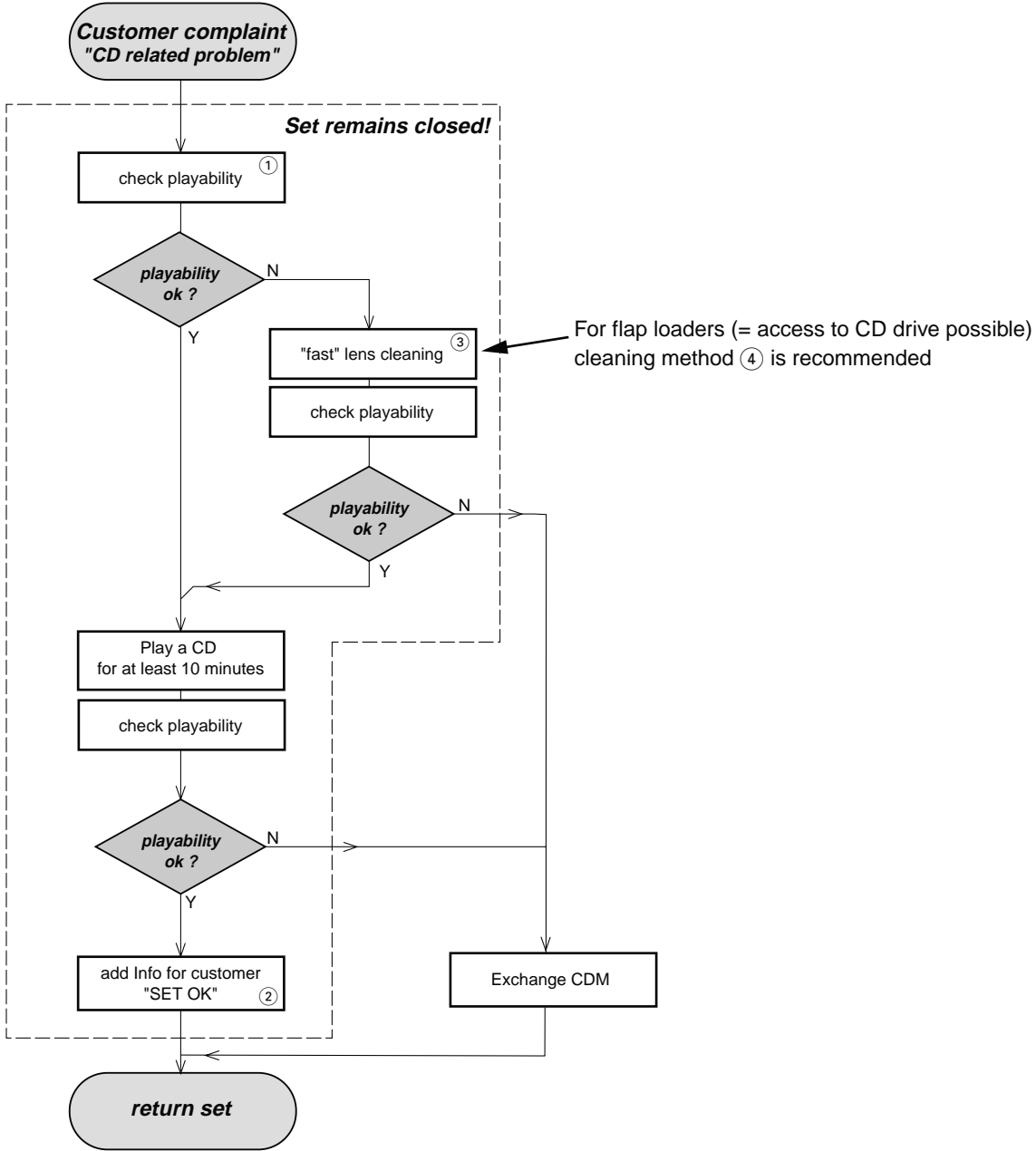

For flap loaders (= access to CD drive possible) cleaning method ④ is recommended

① - ④ For description - see following pages

## INSTRUCTIONS ON CD PLAYABILITY

①

### PLAYABILITY CHECK

For sets which are compatible with **CD-RW** discs  
 use CD-RW Printed Audio Disc .....7104 099 96611  
 TR 3 (Fingerprint)  
 TR 8 (600µ Black dot) **maximum at 01:00**

- playback of these two tracks without audible disturbance  
 playing time for: Fingerprint  $\geq 10$ seconds  
 Black dot from 00:50 to 01:10
- jump forward/backward (search) within a reasonable time

For all other sets  
 use CD-DA SBC 444A .....4822 397 30245  
 TR 14 (600µ Black dot) **maximum at 01:15**  
 TR 19 (Fingerprint)  
 TR 10 (1000µ wedge)

- playback of all these tracks without audible disturbance  
 playing time for: 1000µ wedge  $\geq 10$ seconds  
 Fingerprint  $\geq 10$ seconds  
 Black dot from 01:05 to 01:25
- jump forward/backward (search) within a reasonable time

②

### CUSTOMER INFORMATION

It is proposed to add an addendum sheet to the set which informs the customer that the set has been checked carefully - but no fault was found.

The problem was obviously caused by a scratched, dirty or copy-protected CD. In case problems remain, the customer is requested to contact the workshop directly.

The lens cleaning (method ③) should be mentioned in the addendum sheet.

The final wording in national language as well as the printing is under responsibility of the Regional Service Organizations.

④

### LIQUID LENS CLEANING

**Before touching the lens it is advised to clean the surface of the lens by blowing clean air over it. This to avoid that little particles make scratches on the lens.**

Because the material of the lens is synthetic and coated with a special anti-reflectivity layer, cleaning must be done with a non-aggressive cleaning fluid. It is advised to use "Cleaning Solvent

The actuator is a very precise mechanical component and may not be damaged in order to guarantee its full function. Clean the lens gently (don't press too hard) with a soft and clean cotton bud moistened with the special lens cleaner.

The direction of cleaning must be in the way as indicated in the picture below.

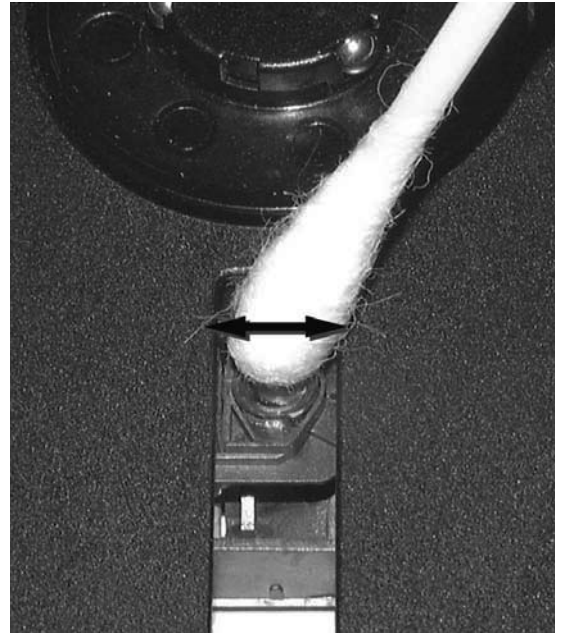



Disassembly Disagrams:

A:Disassemble the bottom cabinet

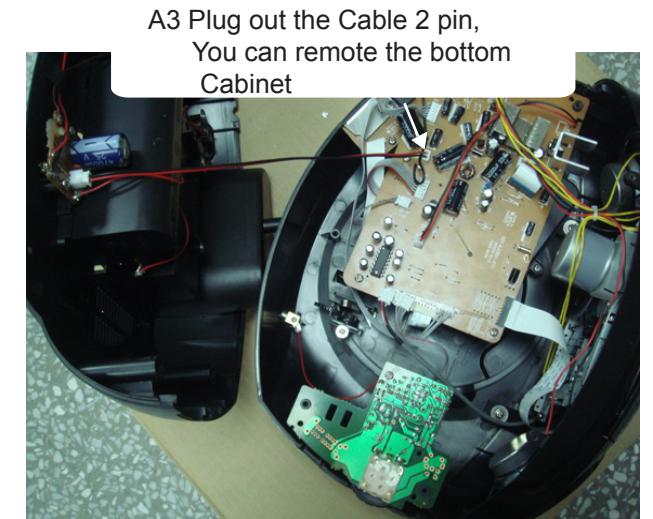

B:Disassemble the Front & Top Cabinet

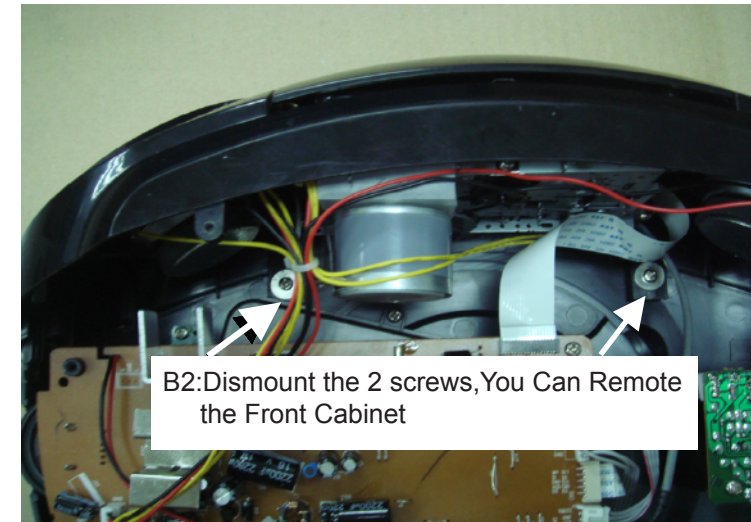
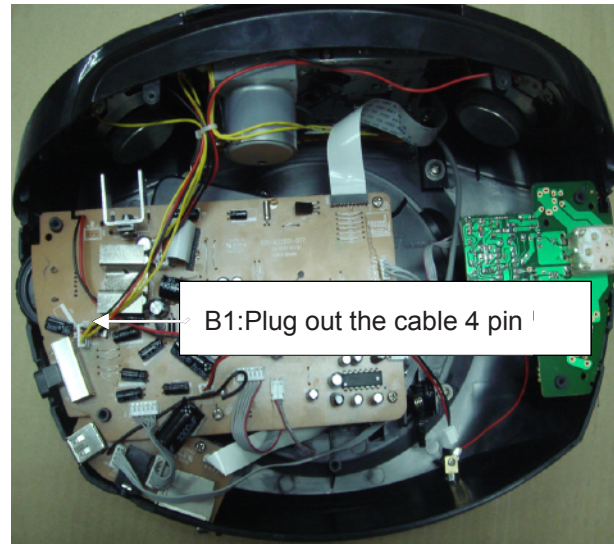

C:Disassemble the Main PCBA

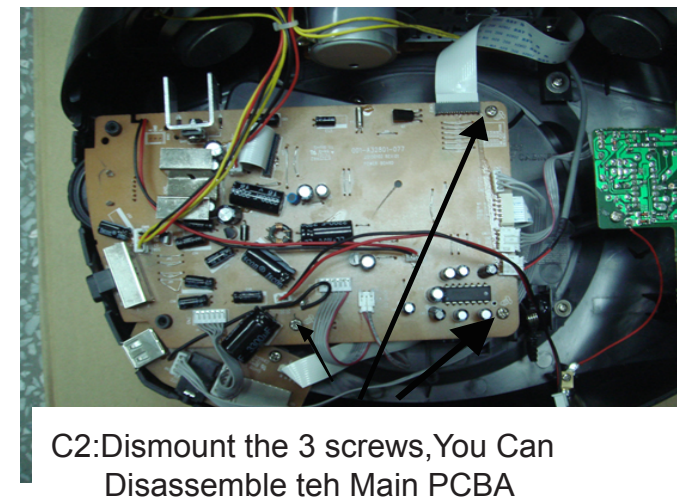
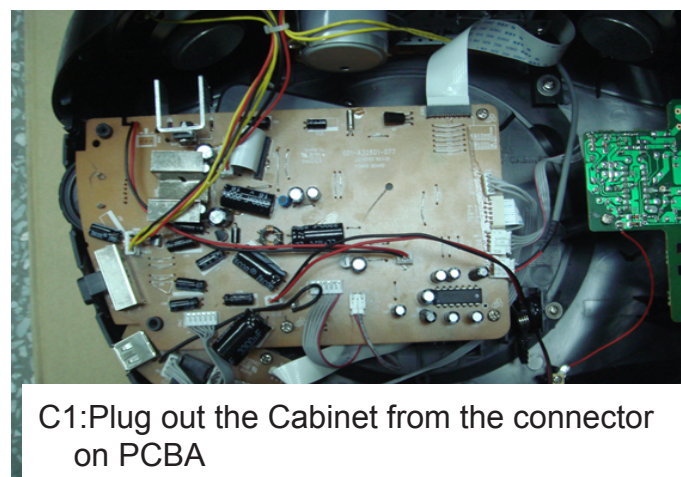

BLOCK DIAGRAM

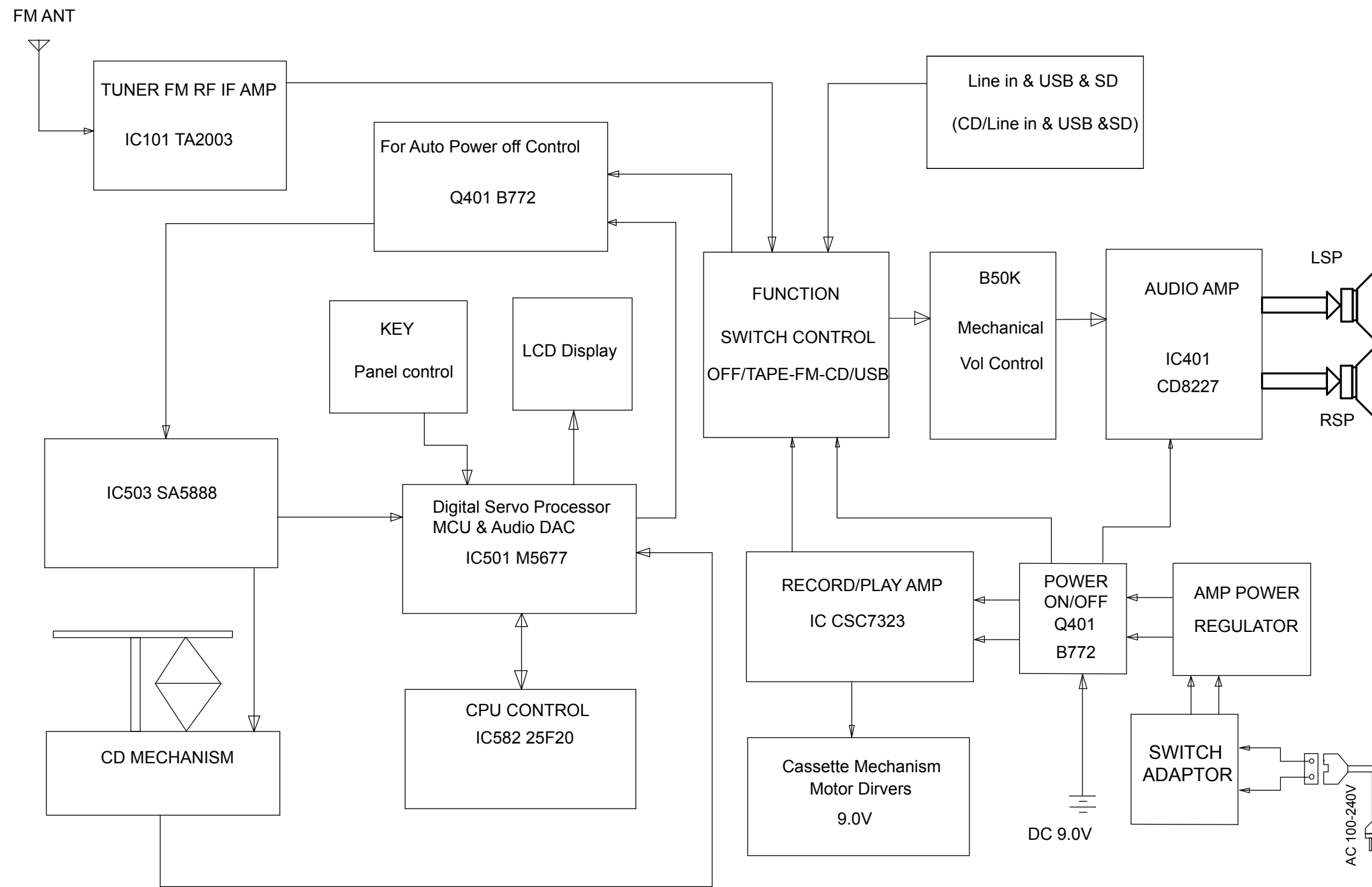



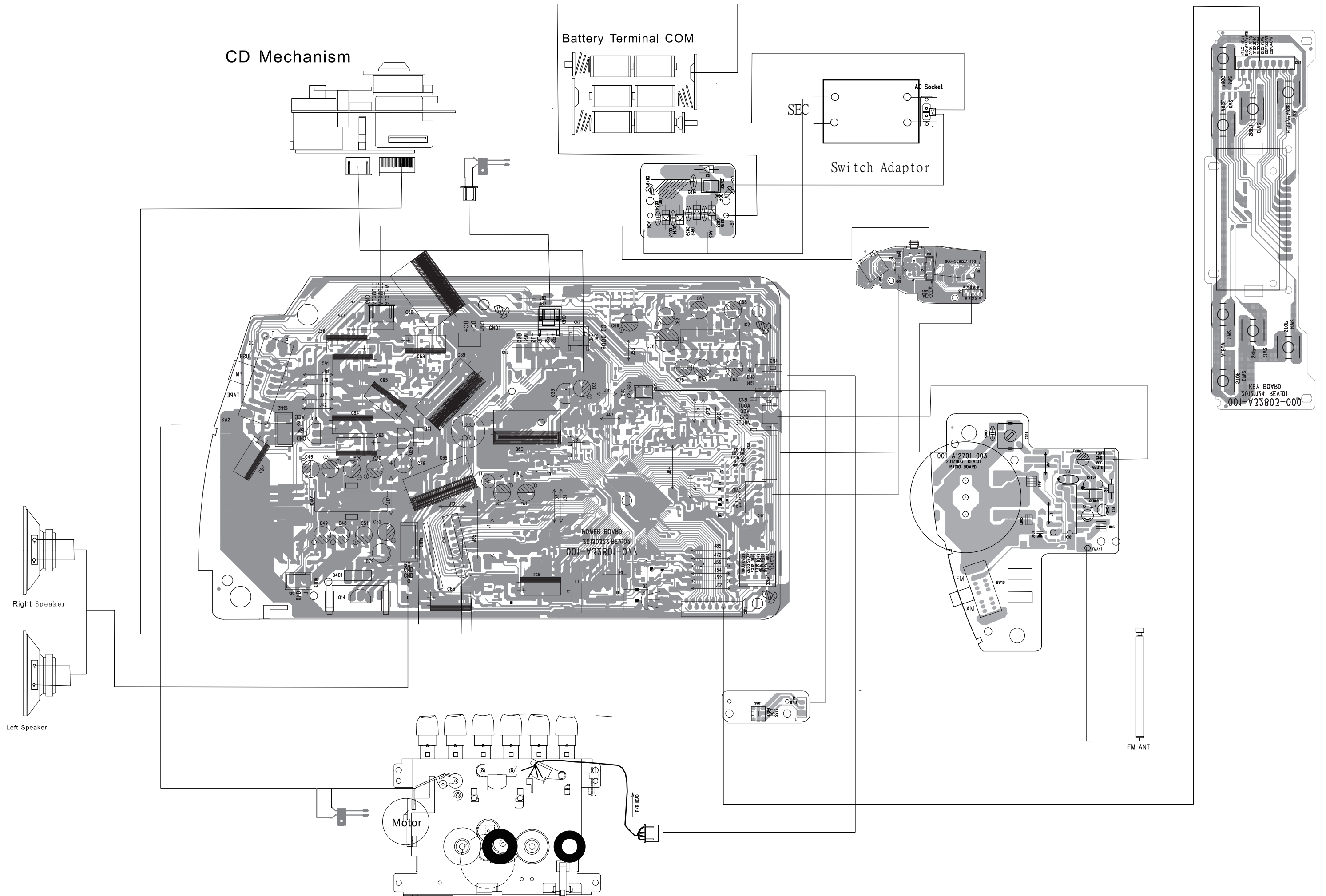

CD & USB & SD Circuit View

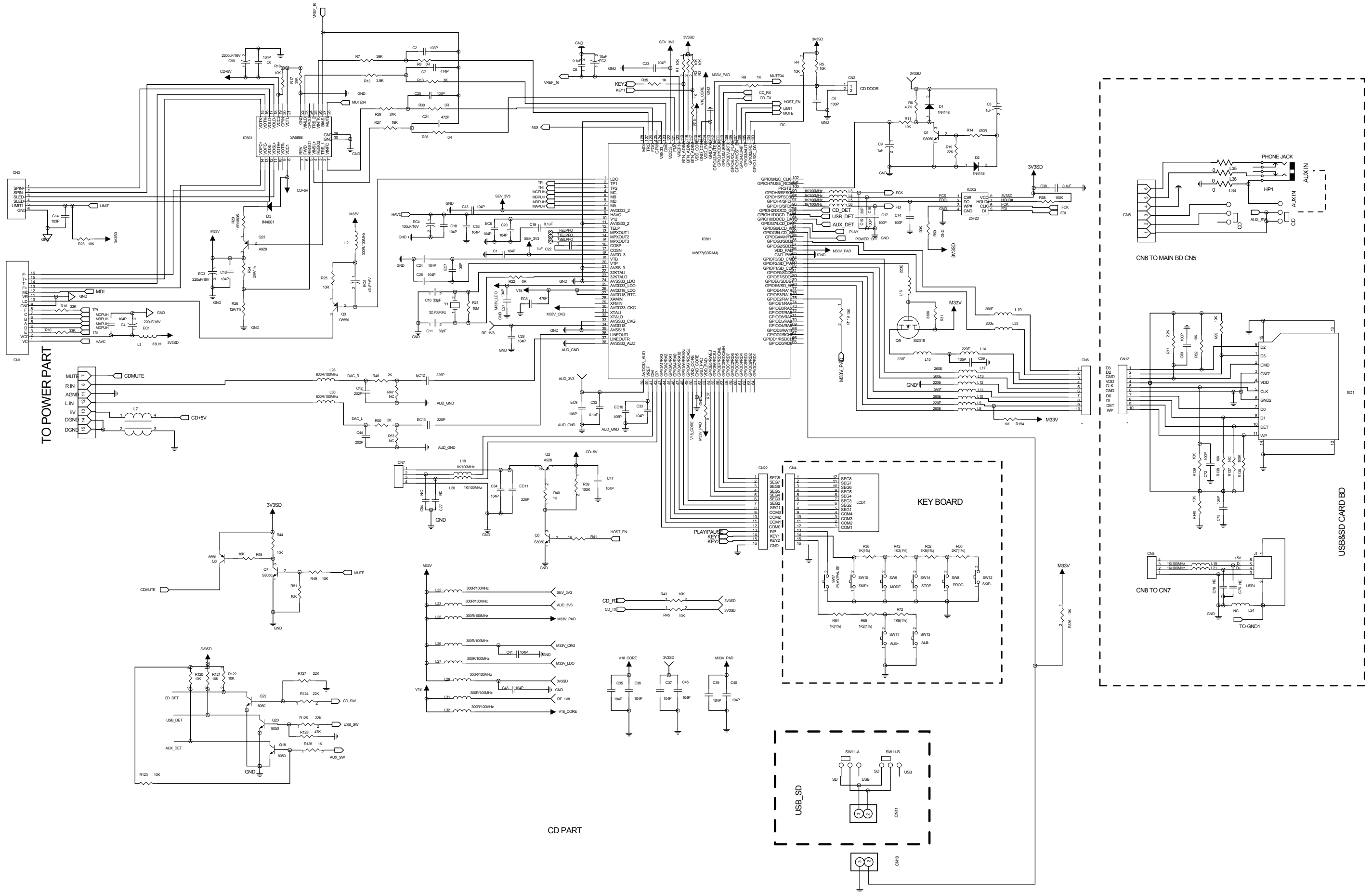

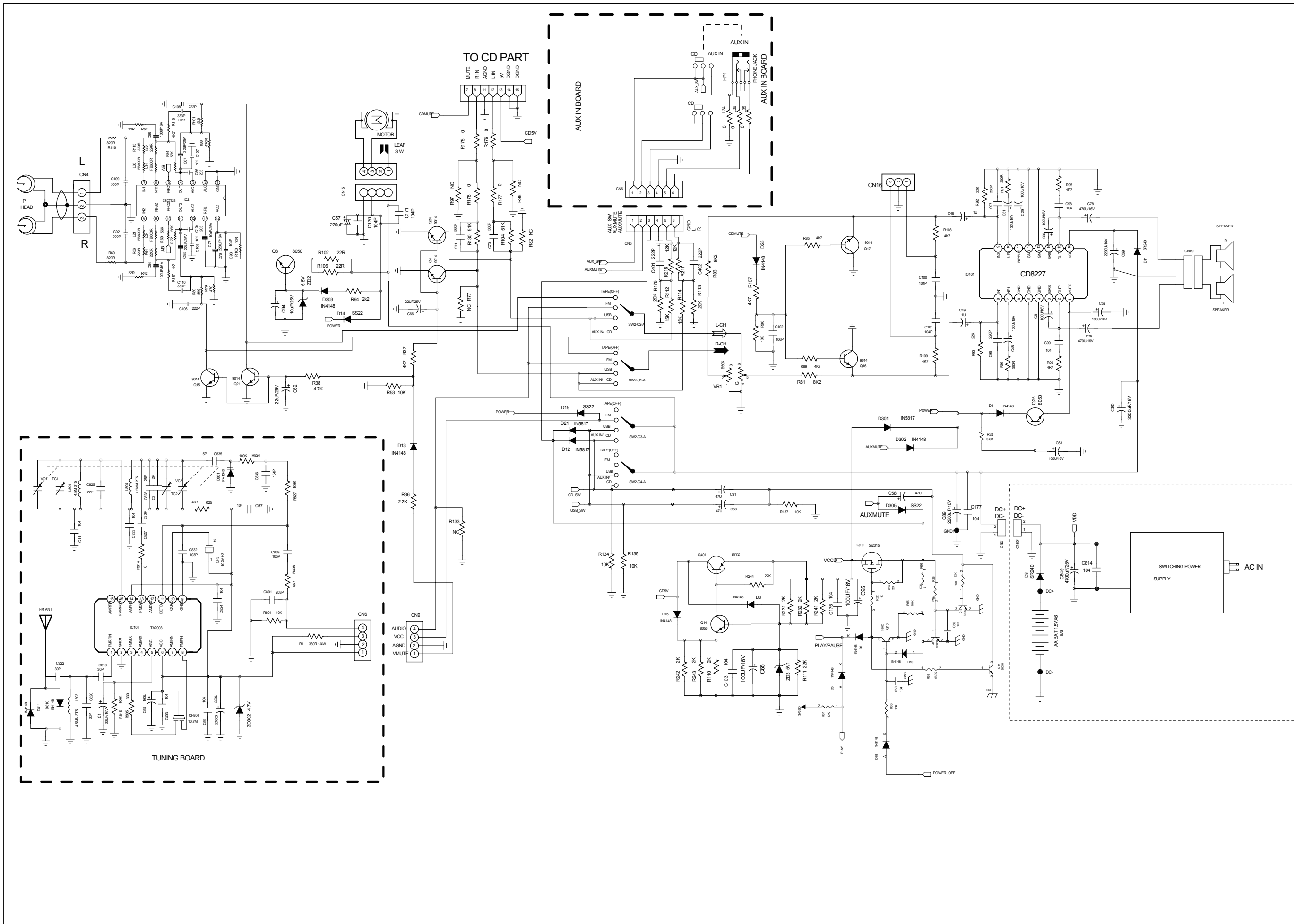

Main PCB Layout View

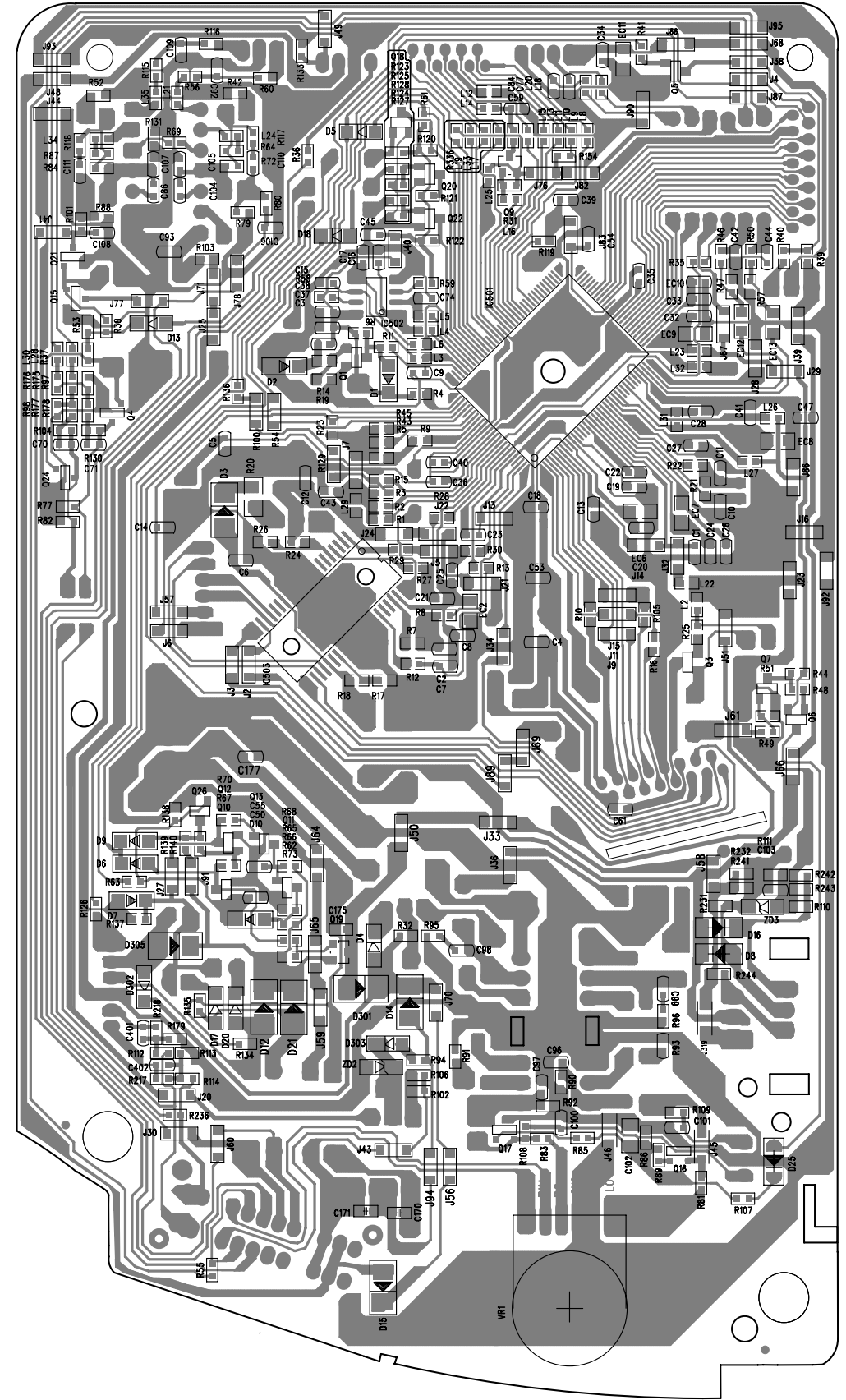
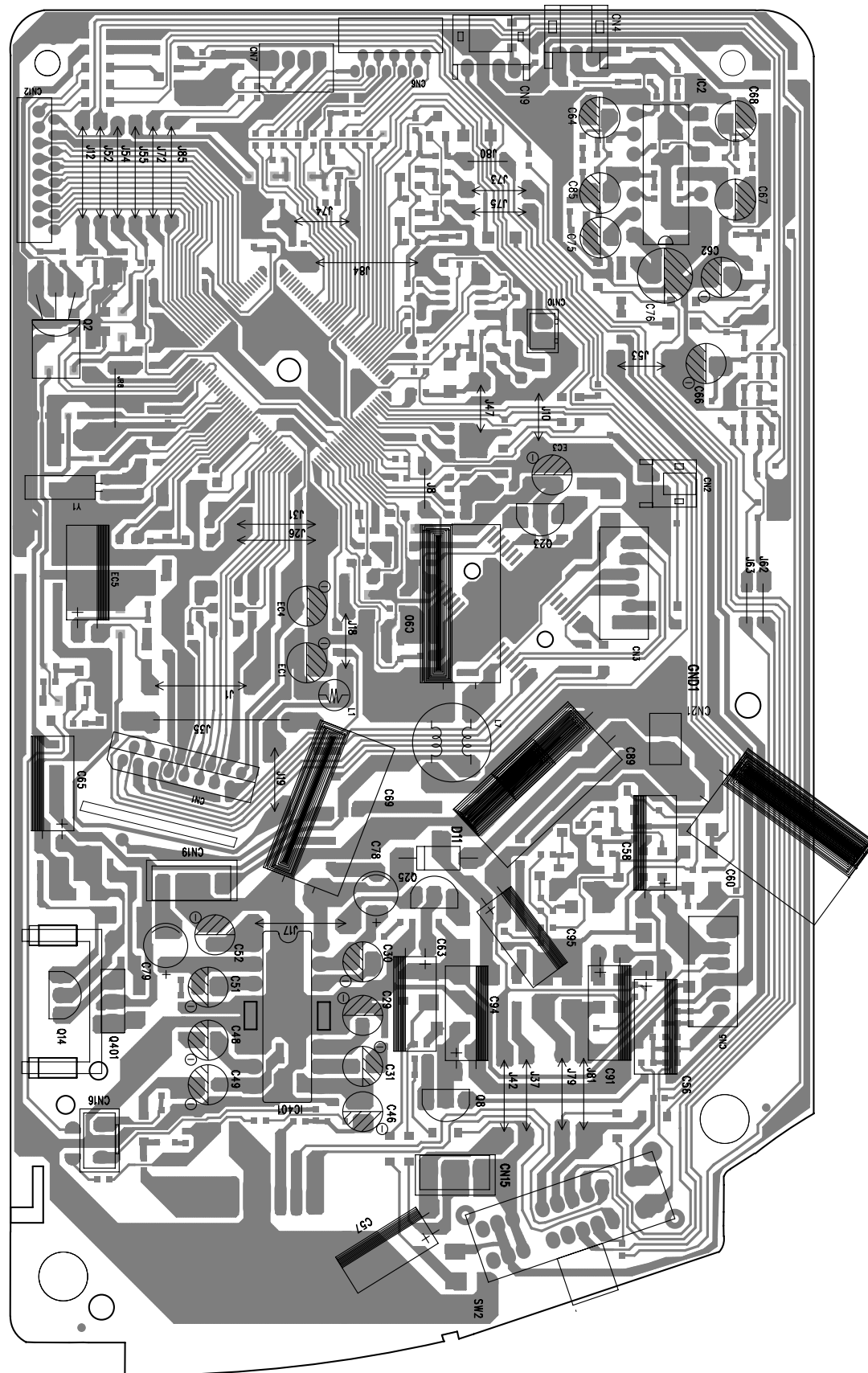

Radio & BBS & Power PCB Layout Top Side View

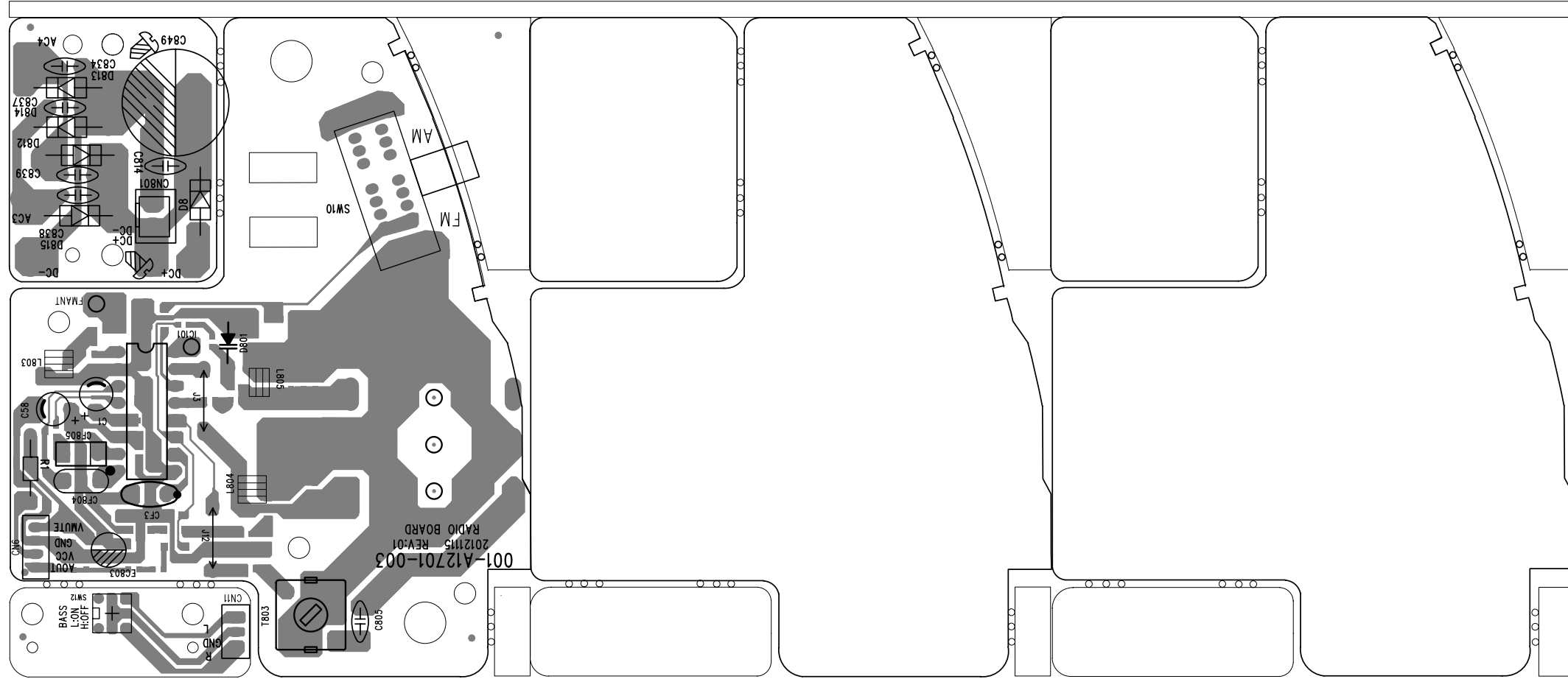

Radio & BBS & Power PCB Layout Bottom Side View

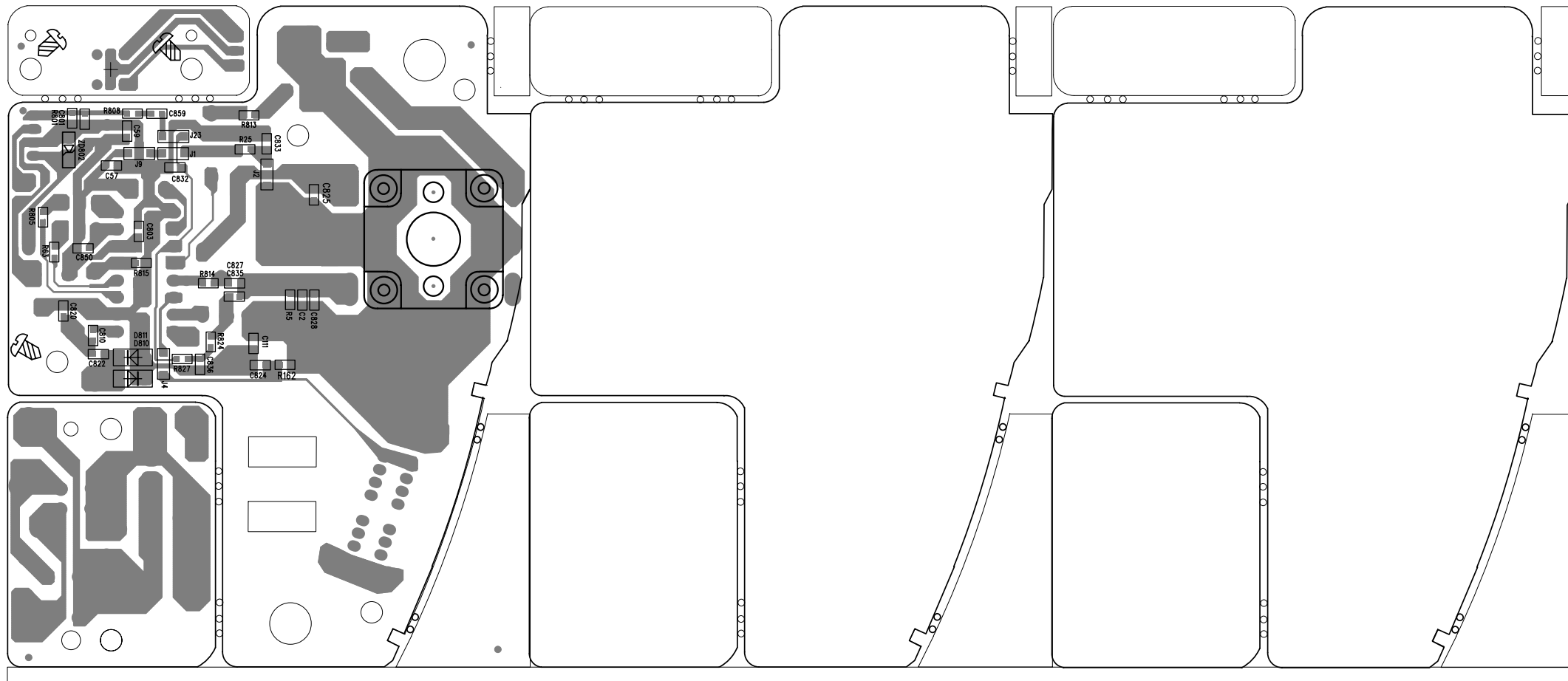



Exploded View Diagram

